

FGi, FXi & FPi 5, 5 Wide & 8 ECO INSET STOVE RANGE – V3 5, 5 & 8 kW Nominal Outputs

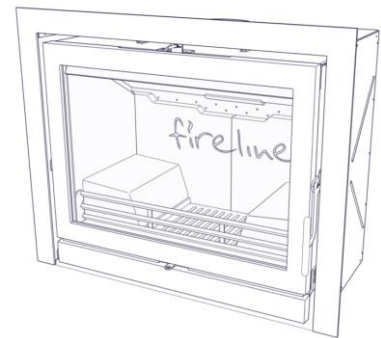

Installation and Operating Instructions



Please hand these instructions to the stove user when the installation is complete. Leave the stove ready for operation and instruct the user in the correct use of the appliance and operation of controls.

Important: – Stoves must be installed by a qualified installer.

Clean Air Act Exemption

The **FGi/FXi/FPi 5, FGi/FXi/FPi 5W and FGi/FXi/FPi 8 Eco** Inset stoves have been exempted under the Clean Air Act 1993 to burn seasoned wood logs in designated smokeless zones in the UK. This is subject to the correct fitting of the air control plate (part and fitting instructions are supplied with the stove) maintaining the air wash control above a minimum setting at all times. **Instructions for wood burning MUST be followed in order to ensure compliance at all times.**



Fireline – A division of:
Charlton & Jenrick Ltd, Unit D Stafford Park 2,
Telford, Shropshire, TF3 3AR
T: 01952 200444 F: 01952 200480



PLEASE READ ALL THESE INSTRUCTIONS CAREFULLY!

For safety reasons it is essential that your stove is correctly installed and operated. Charlton & Jenrick cannot accept responsibility for any fault or consequential problems arising through incorrect installation or operation.

TABLE OF CONTENTS

<u>Section</u>	<u>Page No</u>
1. List of Components	2
2. Component Identification and Assembly.....	2
3. Installation Instructions	3
3.1 Warnings and important safety information.....	3
3.2 Health & Safety Precautions	4
4 Installation Information	4
4.1 Chimney.....	4
4.2 Ventilation	5
4.3 Flue Draught.....	5
4.4 Connection to Chimney.....	5
4.5 Fixing.....	5
4.6 Material Clearances (combustible and non combustible).....	6
4.7 Hearths.....	7
4.8 Commissioning & Handover.....	7
5. Technical Data – Declaration of Performance (DoP).....	8
6. Operating Instructions.....	9
6.1 Safety Notes for your Guidance.....	9
6.2 Clean Air Act.....	10
6.3 Air controls.....	11
6.4 Multifuel Grate.....	12
6.5 Ashpan.....	12
6.6 Cleaning.....	12
6.7 Fuels.....	13
6.8 Important Information for Wood Burning.....	13
6.9 Notes for smokeless fuel burning.....	14
6.10 Lighting the stove.....	15
6.11 Re-fuelling.....	16
6.12 Shutting down.....	16
6.13 Shutting down for prolonged periods.....	16
6.14 Maintenance.....	17
7. Maintenance.....	18
8. Dimensions.....	20
8.1 FGi/FXi/FPi 5 Dimensions	20
8.2 FGi/FXi/FPi 5W Dimensions.....	21
8.3 FGi/FXi/FPi 8 Dimensions	22
9. Frequently Asked Questions.....	23

1. List of Components

Description of Parts	Qty
FXi/FPi Stove Assembly	1
Multi Tool	1
Ash Pan	1
Flue Spigot Collar	1
Spigot Collar fixing screws	3
Pair of Stove Operating Gloves	1
Air Wash operating pin	1
Smokeless Zone Air limiter	1
Side firebricks (5Wide & 8kW only)	2

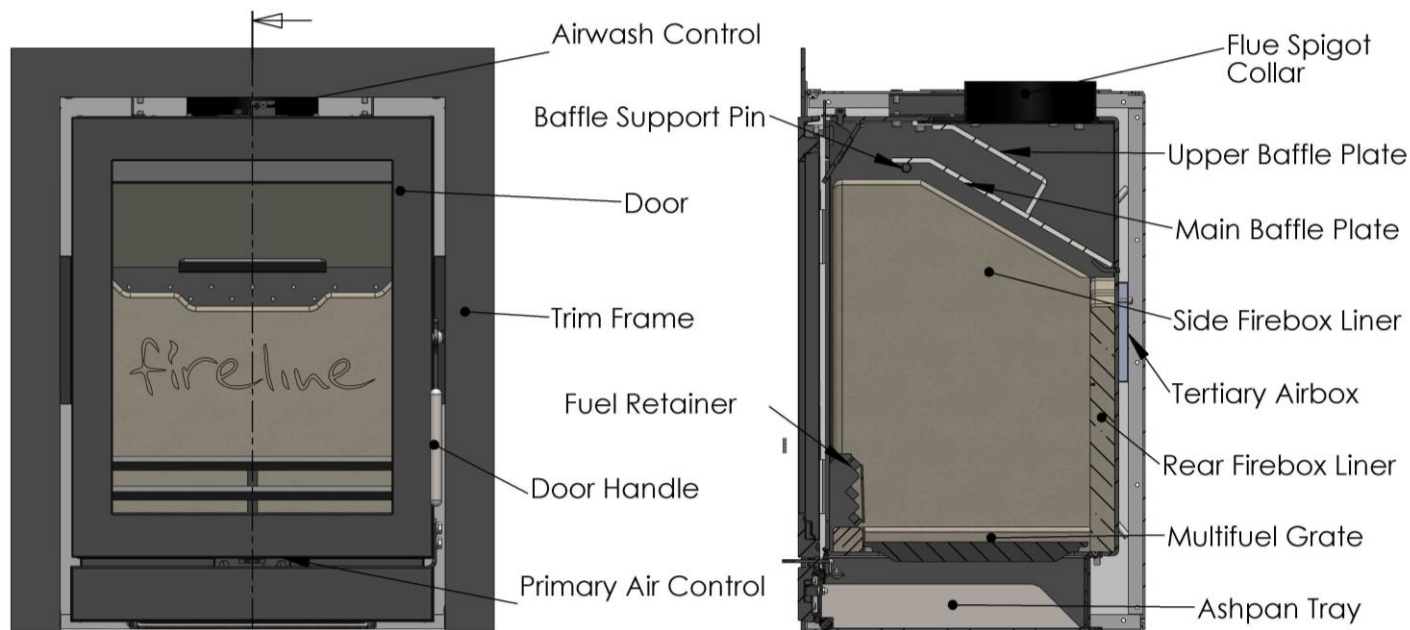
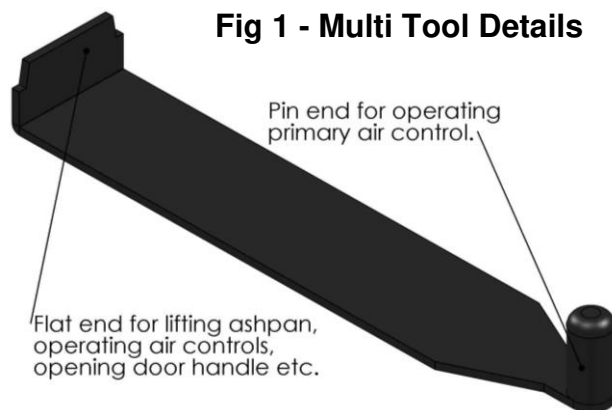

Fig 2 – FGi/FXi/FPi 5, FGi/FXi/FPi 5W, FGi/FXi/FPi 8 Stove Assembly and controls

2. Component Identification and Assembly

Your stove comes packed in a protective plywood crate. Carefully remove the straps and lift off the top and upper crate. Remove any plastic packaging, open the door and remove all the contents. See List of Components section (above) and check contents carefully.

- 2.1 To remove the baffle plate, first remove the fuel retainer by lifting it up and out the front of the stove. Carefully remove the two side liners and the rear liner. Handle & store **very carefully** to one side where they will not get broken.
- 2.2 Now the baffle plate can be removed by lifting off its supports and bringing out through the firebox door opening.
- 2.3 It is sometimes useful to remove the door at this stage by opening and lifting up to slide the hinge pins out.
- 2.4 Screw the air wash control pin into the air wash slider control and secure using the locknut provided.
- 2.5 If installing within a smokeless zone, fit the smoke control zone air limiter bracket according to its instructions.
- 2.6 Proceed to install the stove according to these instructions and current installation standards or HETAS requirements. The internal parts of the stove can be re-assembled as the reverse of the previous removal instructions.

3.0 Installation Instructions

3.1. WARNINGS AND IMPORTANT SAFETY INFORMATION

3.1.1 READ THESE INSTRUCTIONS CAREFULLY BEFORE INSTALLATION!

These instructions cover the basic principles to ensure satisfactory installation of the stove, although detail may need slight modification to suit particular local site conditions. In all cases the installation must comply with current local regulations including Building Regulations, Local Authority Byelaws and other specifications or regulations including UK or EU standards referred to as they affect the installation of the stove. Approved Document J is particularly important for England and Wales and can be downloaded for no cost at:

[https://www.planningportal.co.uk/info/200135/approved_documents/72/part j -
_combustion appliances and fuel storage systems](https://www.planningportal.co.uk/info/200135/approved_documents/72/part_j_-_combustion_appliances_and_fuel_storage_systems)

Also of importance are Approved Documents (A.D.) L1 A and B conservation of fuel and power. The Domestic Heating Compliance Guide will also be found useful.

In addition to these instructions the requirements of BS 8303 and BS EN 15287 must be fulfilled. The installation is a notifiable building works as defined in the building regulations and that it is a legal requirement under England and Wales Building Regulations that the installation is either carried out under Local Authority Building Control approval or is installed by a Competent Person registered with a Government approved Competent Persons Scheme. HETAS Ltd operate such a Scheme and a listing of their Registered Competent Persons can be found on their website at www.hetas.co.uk.

3.1.2 Important Chimney Warning

This stove must not be installed into a shared chimney that serves any other heating appliance.

3.1.3 Extractor Fan Warning

There must not be an extractor fan fitted in the same room as the stove as this can cause the stove to emit fumes into the room. If unavoidable the appliance must be checked with Approved Document A.D. 1.21 and necessary action taken. HETAS can provide guidance of a pressure test procedure to check safe operation of the stove and flue.

3.1.4 Cleaning and Chimney Sweeping

The appliance, flue & chimney must be cleaned and checked internally and externally regularly in use and especially after a period of disuse (e.g. after summer). Remove the side liners and lift down the baffle at least weekly to check for build up of soot or debris on the top from the flue pipe. Remove the baffle and check the flue spigot and connector is fully clear at regular intervals. The chimney and flue connector must be swept at least annually, more often when used with sooty fuels or damp wood. The chimney or flue can usually be swept through the appliance. A wire centred sweeps brush with guide wheel is recommended. Any loose, broken or leaking joints or flue ways **MUST** be repaired immediately.

3.1.5 Fuels

Only use recommended fuels which are seasoned (or kiln dried) wood logs or smokeless briquetted fuels. The appliance can be damaged by burning petroleum coke, liquid fuels or general rubbish and this will invalidate your warranty and risk your personal safety. **The appliance must not be used as a rubbish incinerator.**

3.1.6 Maintenance

Annual checking and servicing of the appliance and flue by a competent engineer is recommended.

3.1.7 Ventilation

Adequate ventilation is ESSENTIAL for the safe and efficient operation of any solid fuel or wood burning appliance. Ventilation MUST be provided where required by the stove output or flue under-performance. Keep all ventilation clear and free of blockage, including any direct outside air connection where used. See VENTILATION in INSTALLATION INFORMATION section.

3.1.8 OVERFIRING WARNING

It is possible to over fire a stove by overloading the firebox with fuel and using too much air – having the air controls open too wide - during the combustion cycle. This will cause overheating and potential damage to parts such as the grate, baffle plates, firebox liners and fuel retainers. **IF ANY METAL PART OF THE STOVE GLOWS RED, INCLUDING THE BAFFLE PLATE OR FUEL RETAINER, IMMEDIATELY REDUCE THE AIR CONTROL SETTINGS UNTIL THE OVERHEATED PARTS OF THE STOVE COOL AGAIN. Failure to do so will damage the stove and invalidate any warranty. Parts damaged by overheating, thermal cracking or even melting are NOT covered by any warranty.**

3.2. Health And Safety Precautions

Special care must be taken when installing this stove to meet all requirements of the Health & Safety at Work act.

3.2.1. Handling

Adequate facilities must be available for unloading and site handling. Stoves are very heavily built so always ask for assistance when lifting and siting them. See Technical Data for weights.

3.2.2. Fire Cement

Some types of fire cement are caustic and should not be allowed to come into contact with the skin. In case of skin contact, wash immediately with plenty of water.

3.2.3. Asbestos

This stove contains no asbestos. If there is a possibility of disturbing any asbestos in the course of installation then please seek specialist guidance and use appropriate protective equipment.

3.2.4. Metal Parts

When installing or servicing this stove, proper care should be taken to avoid the possibility of personal injury. Injury may be caused by component weight, sharp parts or trapping for example and these risks should be identified and minimised.

4.0 Installation Information

4.1. Chimney/flue

The chimney height and the position of the chimney terminal should conform to Building Regulations. Minimum chimney height is 4.5m and the recommended minimum diameter is 150mm wherever possible for safety margin and performance. The chimney must be swept before connection to the stove. Check that the chimney is in good condition, dry and free from cracks and obstructions. The diameter of the flue should not be less than 125mm (spigot diameter) at any point and not greater than 200mm. If any of these requirements are not met, the chimney should be lined by a suitable method. The chimney must be swept before connection to the stove. When using a liner, a 5" 125mm flexible flue liner is permitted be used on these stoves providing that the users only burns smokeless fuel or seasoned wood logs with the air limiter fitted in in full accordance with the wood burning instructions. A 6" 150mm liner is always better where it is possible to use one.

Where the chimney is believed to have previously served an open fire installation, it is possible that the higher flue gas temperature from the stove may loosen deposits that were previously firmly adhered, with the consequent risk of flue blockage. It is therefore recommended that the chimney be swept a second time within a month of regular use after installation.

If you have any doubts about the suitability of your chimney, consult your local dealer or chimney specialist. If there is no existing chimney then either a solid fuel compatible prefabricated block chimney or a twin-walled insulated stainless steel flue to BS 4543 can be used. These chimneys must be fitted in accordance with the manufacturer's instructions and Building Regulations.

4.2. Ventilation

Document J of the Building Regulations states that (except in recently built properties) purpose provided ventilation is not required in England and Wales unless the appliance nominal rated output is greater than 5kW. Over 5kW 5.5 cm² of ventilation (550mm²) is required for every kW output above 5. For example 6.5 kW requires 8.25 cm² and 8 kW needs 16.5cm². In any case, if difficulty in starting the fire or any excessive fuming is experienced, ventilation must be put in place as required to eliminate these flue problems. If a flue draught stabiliser is fitted then extra ventilation is required. See Document J of the Building Regulations for detailed guidance especially in new build properties where purpose provided ventilation may be required.

4.3. Flue Draught

Typically a flue draught at the flue collar of 2.2mm to a maximum 3.5mm water gauge (22 to 35 Pascals) is required for satisfactory appliance performance. This relates to 12-25 Pascals at the higher tapping on EN13240/13229 test rigs. The flue draught should be checked under fire at high output and, if it exceeds the recommended maximum, a draught stabiliser must be fitted so that the rate of burning can be controlled to prevent over-firing.

4.4. Connection to the Chimney

This appliance is **not** suitable for use in a shared flue.

Whilst 6" 150mm diameter flue or liner is recommended wherever possible, a suitable 5" 125mm flexible flue liner is permitted be used on these stoves providing that they only burn smokeless fuel or seasoned wood logs with the air limiter fitted in in full accordance with the wood burning instructions.

An existing fireplace opening can be bricked up or sealed with a register plate. A short length of suitable quality rigid flue pipe of a minimum 125mm internal diameter may then be used to connect the stove to the chimney. This flue pipe should conform to Building Regulations. The stove must be insulated and properly fitted into the fireplace opening by back filling with 6:1 ratio vermiculite & cement mixture using minimal water through the top of the fireplace or flue spigot opening. The surface should be finished using 1:1:8 mix of cement, lime and sand. The connecting pipe is fitted with the spigot pushed up from **inside** the stove and rotated onto its keyhole slots to join to the pipe. If the connecting flue pipe enters the vertical flue way at any other angle except vertically, ensure that the pipe end is no closer (along the axis direction of the pipe) than 76mm to the side or rear chimney walls.

If necessary a hole must be opened up into the flue way above the fireplace in order to fit the appliance to the flue correctly. Please consult HETAS for recommended fitting methods if in doubt. It is essential that all connections between the stove and chimney-flue are sealed and

made airtight with sealing rope, clamping rings and/or fire cement or heat resisting cement where required. This includes sealing any holes in the firebox top or the annulus around the flue spigot to prevent heated convection air being drawn out of the top of the stove or liner insulation materials from dropping through.

Both the chimney and flue pipe must be accessible for cleaning and if ANY parts of the chimney cannot be reached through the stove (with baffle removed), a soot door must be fitted in a suitable position to enable this to be done.

4.5. Fixing

Fix the stove to the back hearth using suitable non-combustible fixings through the base of the outer firebox. If necessary screw the outer firebox to the back-panel by fixing the top or sides of the firebox using suitable non-combustible fixings.

4.6. Material Clearances

4.6.1. Safety Distances from Combustible Surfaces:

Model	Shelf (4"/100mm)	Side surround leg (100mm) (to outer edge of trim)	Side Full Wall (to outer edge of trim)
FGi/FXi/FPi 5	250mm	150mm	350mm
FGi/FXi/FPi 5W	400mm	150mm	350mm
FGi/FXi/FPi 8	400mm	150mm	350mm

In addition it is strongly recommended that any furniture or other combustible materials are kept at least 900mm clear from the front of the stove.

NOTE: Combustible surfaces can be protected from radiant heat from the stove by adding non-combustible heat shielding between the stove and the materials with an air gap behind it. By doing so, safe distances may be substantially reduced in practice.

4.6.2. COMBUSTIBLE SHELVES AND BEAMS

Due to the fact that combustible shelves, timber fireplaces and beams have potentially thousands of possible configurations in conjunction with stoves outset or inserted partially or fully into chambers, it is not possible to give firm guidance on dimensions to these features. As a guideline, materials that are in 'line of sight' to the stove are more likely to overheat due to direct radiation from the stove body than materials that are not in 'line of sight' (e.g. with stove fully inside a chamber). Materials above the stove are far more likely to overheat than materials alongside or below. A guideline limiting temperature for solid timber (not surface finishes) is approximately 80-85 degrees C with a normal ambient room temperature. Temperatures of combustible materials can be substantially lowered with a simple heat shield constructed of a non-combustible material (e.g. metal or fireproof board etc.) and a small air gap (6-12mm for example) between the shield and combustible material.

4.6.3. Distances from NON-combustible materials:

The stove can be recessed in a suitable sized non-combustible fireplace that is just larger than the outer firebox. To conform to building regulations the fireplace recess walls should be at least 200mm thick or each rear leaf at least 100mm thick in the case of a cavity wall at the rear. If these dimensions are not met further protection for any combustible materials must be provided. The walls of the fireplace recess and the hearth must be made of non-combustible material.

6.1.1.

4.7. Hearths:

These stoves require a 125mm thick non-combustible constructional hearth beneath them to protect the building; this can include any solid non-combustible floor. A non-combustible superimposed hearth forming an apron of at least 225mm at the front of the stove and 150mm on either side must also be provided. The superimposed hearth must not be less than 12mm thick and must have a clearly defined edge (change of level) to discourage placing of any combustible materials on or partially over it. Ensure the hearth is flat & level and the back panel and surround are at right angles to the hearth.

The appliance shall be installed on a floor with adequate load-bearing capacity. If the existing construction does not meet this requirement, suitable measures (e.g. load distributing plate) should be provided to achieve it.

4.8. Commissioning and Handover

CO Alarm: Building Regulations require that whenever a new or replacement fixed solid fuel or wood/biomass appliance is installed in a dwelling a carbon monoxide alarm must be fitted in the same room as the appliance. Further guidance is available in BS EN50292:2002 and from the alarm manufacturer's instructions. Provision of an alarm must not be considered a substitute for either installing the appliance correctly or ensuring regular servicing and maintenance of the appliance and chimney system.

Upon completion of the installation, allow a suitable period of time for any fire cement and mortar to dry out. A small fire may then be lit and checked to ensure the smoke and fumes are taken from the stove up the chimney and emitted safely to atmosphere.

Advise the customer not to run the stove at full output for at 3 – 4 days. Explain that stoves can provide much more or less output than their rated 'nominal' heat outputs depending upon fuels, fuel loads used and how they are operated.

Warn the customer that using excessive air (having the air controls open too wide for too long with a full fuel load) can over-fire and irreparably damage the stove. Damage caused by over firing is NOT covered by any warranty.

Left and right firebricks are provided for the FP/FGi5 Wide and FPi8 models for use when burning smokeless fuels only – see section on solid smokeless fuel burning. They are NOT required to be fitted for burning wood but MUST be fitted for burning smokeless fuels. Explain this to the customer and show them how to take them in and out of the firebox.

On completion of the installation and commissioning, check all parts of the appliance are correctly fitted and ensure that the operating instructions and operating tools (including gloves) for the stove are left with the customer. You must be sure to advise the customer on the correct use of the appliance with the fuels likely to be used on the stove and warn them to use only the recommended fuels for the stove.

Advise the user on what to do should smoke or fumes be emitted into the room from the stove – see **Safety Notes** section. The user should be warned that they MUST use a suitable fireguard in the presence of children, aged and/or infirm persons.

5.0 Technical Data & Declaration of Performance (DoP)

Manufacturer: Charlton & Jenrick Ltd.

Range Designation: FG/FX/FP Eco Inset Stoves.

Models: FG/FX/FPi5, FG/FX/FPi5W, FG/FX/FPi8 Eco with nominal outputs of 5kW, 5kW and 8kW.

Intended Use: Domestic heating appliances

Independently Performance & Safety tested by: Kiwa Gastec, NB No: 0558/Kiwa Cermet Italia, NB No: 0476

Constasy of Performance System: ISO9001

Model	FG/FX/FPi5 Eco	FG/FX/FPi5W Eco	FG/FX/FPi8 Eco	Notes
Appliance weight (packed/unpacked) (Kg):	80/70	95/84	118/105	
Approximate Output Range: (kW)	4.0-6.0	4.3-6.5	5.5-11.0	
Harmonised EN European Standard (hEN):	EN13229: 2001 Amd 2: 2004	EN13229: 2001 Amd 2: 2004	EN13229: 2001 Amd 2: 2004	
Additional Characteristics Test Standard:	DIN +	DIN +	DIN +	
Additional Particulate Emission Test Standard:	PD6434	PD6434	PD6434	
Performance Characteristics using Wood Fuel				
Test Report Issue Date:	11/17	11/17	11/17	
Total Efficiency: (%)	81.0	78.0	78.4	
Declared nominal output: (kW)	5.0	5.0	8.0	
Tested nominal Output: (kW)	5.0	5.0	7.9	
Tested wood re-fuelling interval: (h)	0.82	0.8	0.78	
Flue gas mass flow: (g/s)	3.6	4.4	5.8	
Mean CO emission (@13% O ₂) : (%) (Nmg/m ³)	0.06 (750)	0.07 (875)	0.05 (625)	
Mean C _n H _m emission (@13% O ₂): (Nmg/m ³)	24	35	27	
Mean NO _x emission (@13% O ₂): (Nmg/m ³)	84	83	83	
DIN+ particulates (@13% O ₂): (Nmg/m ³)	11	15	15	
PD6434 Particulate Emissions High output: (gh ⁻¹)	2.0	3.5	2.6	
PD6434 Particulate Emissions Low output: (gh ⁻¹)	1.8	1.6	1.6	
Optical Density Time > 0.2 High (Mins)	0.6	1.2	1.1	
Optical Density Time > 0.2 Low (Mins)	0.6	0.0	0.8	
Mean Flue Temperature: (Deg C)	288	292	331	Nominal
clearSkies Level	5	5	5	
EEL Labelling Category	A+	A	A	
Approximate Max Log Length: (mm)	300	395	540	
Performance Characteristics using Ancit Briquetted Smokeless Fuel				
Test Report Issue Date:	10/2014	10/2014	10/2014	
Total Efficiency: (%):	76.4	76.5	77.0	
Declared nominal output: (kW)	5	5	8	
Tested nominal output: (kW)	5.2	5.2	8.5	
Tested re-fuelling interval: (h)	1.05	1.02	0.97	
Flue gas mass flow: (g/s)	3.8	4.2	5.9	
Mean CO emission (@13% O ₂) : (%) (Nmg/m ³)	0.09 (1125)	0.09 (1125)	0.07 (875)	
Mean C _n H _m emission (@13% O ₂): (Nmg/m ³)	33	12	19	
Mean NO _x emission (@13% O ₂): (Nmg/m ³)	91	144	115	
DIN+ particulates (@13% O ₂): (Nmg/m ³)	33	35	40	
Mean Flue Temperature: (Deg C)	275	253	297	Nominal
Safety Distances From Combustibles				
Shelf: (mm)	250	400	400	
Side Full Combustible Wall	350	350	350	
Side Surround Leg: (mm)	150	150	150	

Signed:

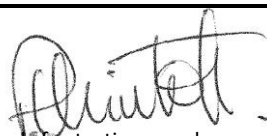

Peter Mintoft

Director

November 2017

NOTE: Refuelling intervals for testing are chosen according to the standards concerned for performance testing and are comparative only. They **do not** relate directly to re-fuelling intervals that can/might/will be achieved on an installed product. Re-fuelling intervals of 1-1.5h for wood and 3-4+ hours for briquetted smokeless fuels would be more usual. Under normal conditions on a low air control setting stoves should stay in overnight on suitable briquetted smokeless fuel.

6.0 Operating Instructions

6.1. Safety Notes for your guidance

6.1.2. **FIRES CAN BE DANGEROUS** – Always use a fireguard to BS 8423:2002 Fireguards for use with solid fuel appliances in the presence of children, the elderly or the infirm.

6.1.3. **DO NOT perform modifications to the appliance as this could seriously compromise safety in operation.**

6.1.4. **DO NOT OVERFIRE** – it is possible to fire the stove beyond its design capacity, this could buckle parts and damage the stove, so watch for signs of over firing – if any part of the stove starts to glow red, including baffle plate or fuel retainer, the fire is in an over fire situation and the controls should be adjusted accordingly. Never leave the stove unattended for long periods without first adjusting the controls to a reduced and safe setting – **careful air supply control should be exercised at all times.**

6.1.5. **WARNING – FUME EMISSION**

Properly installed and operated, this appliance will not emit fumes. Occasional fumes from de-ashing and refuelling may occur which is not normally of serious concern. **However, persistent fume emission is potentially dangerous and must not be tolerated.**

If fume emission does persist, then the following immediate action should be taken: -

1. Open doors and windows to ventilate room
2. Let the fire out, or remove and safely dispose of fuel from the appliance.
3. Check for flue chimney blockage and clean if required.
4. Do not attempt to re-light the fire until the cause has been identified and corrected.

If necessary, seek professional advice from chimney or stove specialists.

Important! – Do not fit an extractor fan in the same room as this appliance.

6.1.6. **IN THE EVENT OF A CHIMNEY FIRE**

- Raise the alarm to let others in the house know.
- Call the Fire Service
- Reduce the appliance burning rate by closing all air controls fully.
- Move furniture and rugs away from the fireplace and remove any nearby ornaments.
- Place a fireguard or spark guard in front of the stove.
- Feel the chimneybreast for sign of excessive heat.
- Do not relight the fire until the chimney and flue ways have been examined by a professional.

If the wall is becoming hot, move the furniture away. Ensure that the Fire Service can gain access to your roof space in order to check this area for signs of fire spread.

6.1.7. **CO ALARMS**

Your installer should have fitted a CO alarm in the same room as the appliance. If the alarm sounds unexpectedly, follow the instructions given under “Warning Note” below.

WARNING If the CO Alarm sounds unexpectedly:-

1. Open Doors and windows to ventilate the room and then leave the premises.
2. Let the fire go out.

6.1.8. Warnings:

This appliance is **not** designed for open operation and therefore should **not** be operated with the doors open.

This stove is designed to burn wood and smokeless fuels cleanly with high efficiency. However, for this product to work properly it must be used correctly. If used correctly this stove will burn with the very useful feature of clean glass.

It is **essential** that the stove has an adequate air supply for combustion and ventilation. DO NOT block any ventilators provided. The primary, secondary and tertiary air inlets and any room ventilation must be kept clear of obstruction.

Warning! This appliance will be very **hot** when in operation and due care should be taken when operating the controls. A tool and pair of quality leather gloves are provided to assist safe operation.

Do not use an aerosol spray on or near the stove when it is alight.

6.2. The Clean Air Act 1993 and Smoke Control Areas

Under the Clean Air Act local authorities may declare the whole or part of the district of the authority to be a smoke control area. It is an offence to emit smoke from a chimney of a building, from a furnace or from any fixed boiler if located in a designated smoke control area. It is also an offence to acquire an "unauthorised fuel" for use within a smoke control area unless it is used in an "exempt" appliance ("exempted" from the controls which generally apply in the smoke control area).

In England appliances are exempted by publication on a list by the Secretary of State in accordance with changes made to sections 20 and 21 of the Clean Air Act 1993 by section 15 of the Deregulation Act 2015. Similarly in Scotland appliances are exempted by publication on a list by Scottish Ministers under section 50 of the Regulatory Reform (Scotland) Act 2014. In Northern Ireland appliances are exempted by publication on a list by the Department of Agriculture, Environment and Rural Affairs under Section 16 of the Environmental Better regulation Act (Northern Ireland) 2016. In Wales these are authorised by regulations made by Welsh Ministers.

The Fireline **FGi/FXi/FP5, FGi/FXi/FPi 5W and FGi/FXi/FPi 8** stoves have been recommended as suitable for use in smoke control areas when burning wood logs. This is conditional upon fitting the supplied secondary air control limiters and following the wood burning instructions precisely. Suitable Authorised fuels can also be used in the appliances in Smoke Control Areas (see Authorised fuels for use in Smoke Control Areas here <https://smokecontrol.defra.gov.uk/fuels.php>).

Further information on the requirements of the Clean Air Act can be found here: <https://www.gov.uk/smoke-control-area-rules> . Your local authority is responsible for implementing the Clean Air Act 1993 including designation and supervision of smoke control areas and you can contact them for details of Clean Air Act requirements.

6.3. Air Controls

Keep air controls and inlets/outlets clean and free from ash or debris at all times. Keep ventilator air inlet grilles (if fitted) clean and clear at all times.

Do not leave air controls fully open unless monitoring the fire as over firing damage (typically buckling of components) can result which is not covered by any warranty.

Air Control Operation

6.3.1. Primary air - under grate

The tab lever with a hole in it just below the main glass window controls the primary air supply to the under grate area. The open position for the primary air slider should only be used for smokeless fuel operations when it will control the burning rate and heat output. Take care not to open it too far for too long as this can cause over-firing. Unless boosting a low fire bed or your flue draught is very low it is not necessary to use primary air at all for wood burning – keep it closed.

6.3.2. Secondary Air - Air Wash

All Charlton & Jenrick stoves are provided with a sophisticated “air wash” system to assist in keeping the fire as visible as possible and reducing (not eliminating) cleaning intervals. This secondary air supply to the stove is controlled through the slider above the door. The Clean Air Act air restrictor bracket will deliberately prevent full closure of this control. Set the secondary air wash control only about 4mm open for briquetted smokeless fuels, opening it further will just reduce efficiency. It may be opened almost fully (depending upon flue draught) for wood burning if a high burn rate/heat output required. The closed position of the air wash control should only be used if absolutely necessary for very slow burning and when burning wood will cause the glass to become blackened, the chimney to gradually become tarred and smoke to be emitted from the stove. This is not recommended.

6.3.3. Wood burning:

Move the air wash slider fully to the right (open) for maximum air to start or revive a wood fire. Returning the lever towards the centre position will reduce the air supply progressively to reduce the burn rate. The nominal burn rate is usually achieved when the stove is fully warmed up (2-3 loads of logs) and burning dry hardwood logs by having the lever very approximately 12-15mm from the closed position. This is only a rough guide as flue and fuel conditions will vary the required position. The maximum position will supply a boost of air to get new fuel burning quickly in order to minimise smoke. Do not leave on maximum setting unless monitoring the fire to ensure over firing damage does not occur. The fire will automatically be supplied with the correct mix of tertiary air for complete combustion. **NOTE: It is not normally necessary to open the primary air at all once the stove is warmed up when burning wood unless the flue draught or wood moisture are out of specification.** Doing so may over fire the stove.

6.3.4. Smokeless coal fuel burning:

Move the air wash control slider fully to the right side and open the primary air slider below the glass panel fully for starting or reviving a coal fire. Returning the slider towards the closed position will reduce the air supply progressively as the fire warms up. Do not leave any control at maximum setting unless monitoring the fire to ensure over firing damage does not occur **NOTE: It is not necessary to open the secondary air slider more than 3-4mm once the stove is warmed up when burning smokeless coals. Opening any further will keep the glass slightly cleaner but will reduce thermal efficiency.**

6.3.5. Tertiary Air

This appliance is also fitted with a draught controlled tertiary air system that burns otherwise uncombusted gasses thereby improving efficiency, increasing heat output and decreasing unwanted emissions. The Tertiary air supply to the stove is controlled automatically by the draught in the flue and firebox. At certain stages of burning you will notice “jets” of flame emerging near the air holes to the rear of the firebox. This is not always visible depending upon the fuels used and burn cycle stage so there is nothing untoward if it cannot be seen.

6.4. Multifuel Grate

Your stove is fitted with a multifuel grate. A build up of wood ash when burning wood will not harm the grate and indeed wood is said to burn well on a bed of ash but excessive wood ash build up is not recommended. Smokeless fuel ash must be regularly removed and NOT allowed to build up under the grate.

The tab lever with a hole in it just below the main glass window controls the primary air supply to the under grate area for burning briquetted smokeless fuels only. The primary air supply will normally be around 50% open (100% open for 8kW version) for nominal output at average flue draughts but will vary from one installation to another.

The primary air control must be closed when burning wood under normal circumstances.

Opening the primary air control too wide can over-fire the stove and permanently damage it if left in operation. Any such over-firing damage is NOT covered by any warranty.

6.5. Ashpan

The ash pan assembly has seals around it that must be well maintained for correct burning of wood with the primary air supply closed. If air leaks that may develop due to seal wear or damage are not corrected then wood burning may become difficult to control. Check and maintain the sealing of this area very carefully.

It is essential that you empty the stainless steel ash pan regularly when burning coal type fuels. Use the flat end of tool to lift the ash pan out of the stove. DO NOT allow coal ash to build up underneath the bed as this may cause damage to the grate.

6.6. Cleaning

Glass: Despite the advanced air wash system provided, the glass will still need cleaning from time to time depending on the fuel quality and burning rates used. Never clean glass when the stove is hot. Always use stove glass cleaner or ceramic hob cleaner, which is available from your stove retailer or supermarket. As an alternative, use a wet cloth with some of the wood ash if burning wood but be very careful to use very clean ash so as not to scratch the glass. DO NOT use coal ash to clean the glass.

Outer body: The outer body simply needs to be dusted or wiped with a clean dry cloth from time to time. DO NOT use wet cloths as it can spread plaster, cement, fire cement or fire board dust and subsequently cause the paint to turn grey with heat where it has been wiped. DO NOT use any kind of furniture polish or cleaning agent other than your stove suppliers recommended paint.

Inner firebox: Brush the inside of the firebox clean from time to time to check the integrity of the plates and liners etc. See Maintenance Guide section for instructions on how to remove parts of the stove. It is not normally necessary to paint inside the firebox due to the high temperatures that mean that the paint does not have much effect before being burnt off. Steel and ceramic firebox liners are very resilient firebox materials and will give reliable service without major cleaning or work on the firebox. The ceramic firebox linings may require replacement occasionally depending upon fuels and the type of usage experienced. Firebox

linings are able to continue in service with cracks or repairs by fire cement, as long as the steel underneath is not exposed to the fire. Firebox linings are not covered by warranty, as they are a wearing consumable part.

Baffle: It is essential to check the top of the baffle for build up of soot and ash regularly when in use and after a long period of disuse. From time to time remove the baffle if necessary to ensure that the flue way entrance is completely clear. Baffle plates will require replacement from time to time and are a wearing consumable part.

Air Supply: It is essential to check any air supply ventilator in the property is fully clear and open if installed.

6.7. Fuels

The appliance is fitted with a versatile multifuel grate and has been tested and approved burning dry, well-seasoned logs (<20% moisture) or briquetted Maxibrite smokeless fuel. These are the recommended fuels. For other fuels please contact the manufacturer for advice.

The side firebricks supplied must be used for burning smokeless briquetted fuels on FPi5W and FPi8 models. The side firebricks are NOT required for wood burning.

Note: Warning!- Petroleum coke fuels or household waste must not be burnt on this appliance.

Should any difficulties arise over fuel quality or suitability, consult your local approved fuel merchant.

6.8. Important Information for Wood Burning

With a full load of wood and burning near nominal output the stove will typically need to be refuelled approximately every 45 min to 1.5 hours but this is entirely dependent on fuel quality. One or two large logs will generally burn longer and cleaner than a number of smaller ones. Wood can usually be stacked higher in the stove than solid mineral fuel but care must be taken that logs do not touch the baffle or the glass panel. **Do not stack logs above the level of the rear firebox liner brick at the back of the stove.**

Wood burns most efficiently with the **primary air controls closed** and the **secondary (air wash) controls open**. Carefully adjusting the secondary air controls and fuel load will then control the burn rate of the stove. Typical air wash openings of 3-6mm are common for nominal outputs depending on fuel quality and draught from the chimney which will differ in each installation. Always make sure that flames are visible above the wood rapidly after re-fuelling for cleanest burning. **Burning without flames above the fuel will create unnecessary smoke and poor heat output.** **After re-fuelling open the air wash control fully to the right side for 3 minutes or until the logs are fully blackened to achieve full flames above the fuel.** Move the door ajar for a short time if necessary to establish the flames.

Wood burns well on a bed of ash and it is therefore only necessary to remove surplus ash from the stove occasionally.

Burn only dry, well-seasoned wood, which should have been cut, split and stacked - under cover from rain - for at least 12-24 months with free air movement around the sides of the stack to enable it to dry out. A good burn-ready alternative is kiln dried wood logs. Burning wet or unseasoned wood will create tar deposits in the stove and chimney and will not produce a satisfactory heat output. **Wood that is not properly dry ('dry' is considered to be less than 20% internal moisture content) uses up energy from the burn process to evaporate the water inside the wood thus creating very poor conditions for combustion.** The main cause of burning

problems with wood stoves is due to excessively damp wood. Wood can appear perfectly dry on the outside but still contain 40-50% water on the inside. A moisture meter can be purchased from stove and equipment suppliers if you wish to check your wood source is correct. Split a log and check the inside as well as the outside.

The ash pan assembly has seals around it that must be well maintained for correct burning of wood with the primary air supply closed. If air leaks that may develop due to seal wear or damage are not corrected then wood burning may become difficult to control. Check and maintain the sealing of this area very carefully.

6.8.1. Refuelling on to a low fire bed

If there is insufficient burning material in the firebed to light a new fuel charge, excessive smoke emission can occur. Refuelling must be carried out onto a sufficient quantity of glowing embers and ash so that the new fuel charge will ignite in a reasonable period. If there are too few embers in the fire bed, add suitable kindling and firelighter if necessary to prevent excessive smoke.

6.8.2. Fuel overloading

The maximum amount of fuel specified in this manual should not be exceeded, overloading can cause excess smoke. Never load fuel above the back firebrick firebox liner or allow it to touch the glass. All models max log diameter = approx. 150mm. Max length = 300mm for 5, 395mm for 5 Wide and 540mm for 8 models. One log is acceptable ONLY if loading onto a hot, well established fire bed.

6.8.3. Operation with door left open

Operation with the door open can cause excess smoke and spillage into the room. The appliance must not be operated with the appliance door left open.

6.8.4. Primary Air left open

Operation with the primary air controls left open can create excess smoke and over-fire the stove if left open when burning wood. The appliance must not be operated on wood with primary air controls or door left open. Leaving the door ajar when hot can also cause over firing and smoke emissions.

6.9. Information on Smokeless Fuel (Maxibrite) burning

The side firebricks supplied must be used for burning smokeless Maxibrite, briquetted fuels on FPi5W and FPi8 models see diagram below. Briquetted smokeless coal type fuels require very different burning conditions to log burning and the stove controls allow for this. Set the secondary airwash control at about 4mm maximum open (wider will reduce efficiency) and set the primary air control as required to adjust the burn rate. Once the initial charge of fuel is glowing well with full primary air, re-fuel with a deep bed using these types of fuel but do not go above the rear firebox lining board or put excessive fuel on top of the side firebricks on the FPi5W and FPi8. Maxibrite and other smokeless briquetted fuels can burn with very little primary air and stay in for many hours to be revived after an overnight burn for example. NEVER use household coal, petroleum (pet) coke or any grade of smoky coals.

6.10. Lighting the stove

We recommend that you have two or three small fires before you operate your stove to its maximum heat output. This is to allow the paint to cure in steadily and to give a long service life of the paint finish. During this curing in process you may notice an unpleasant smell whilst the finishes finally cure. It is non-toxic, but for your comfort we would suggest that during this period you leave all doors and windows open.



First, open the secondary air wash slider control fully. Load the firebox with some fully dry small or split logs in a crossed pattern. Make sure the grate is well covered and no big gaps are present.

Next add plenty of starting fuel, i.e. paper, dry kindling sticks and a firelighter ON TOP of the 4 logs. A crib lattice pattern tends to work well. If using Maxibrite, place a layer of Maxibrite into the firebox on the base as well and omit the large logs but use plenty of kindling with briquettes all around so that the charcoal from the wood ignites the Maxibrite well.

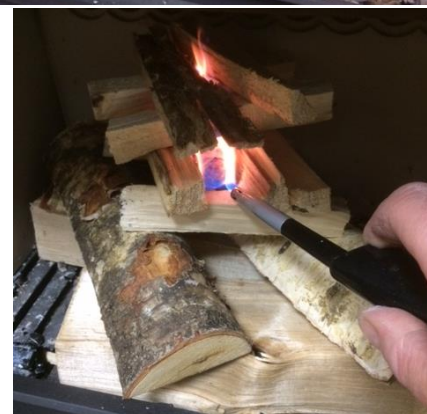

Light the firelighter(s), leaving the air controls fully open the door slightly ajar for 5-10 minutes to enhance initial starting and reduce smoke emission – DO NOT leave the stove unattended if you find it necessary to leave the door ajar. The kindling will burn and set light to the logs by radiation and breaking down to charcoal gradually and with fewer emissions than the traditional logs on top methods.

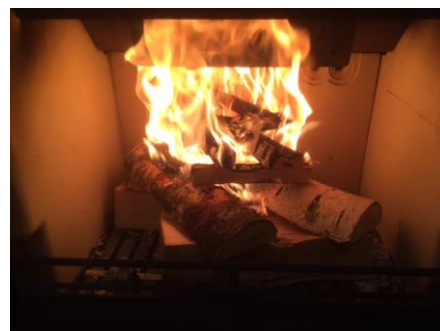

Allow the fuel to reach a steady burn and usually the initial fuel can be left to burn down to nearly charcoal without much further attention. Next build the fire up carefully by adding a couple of small split logs or a relatively small amount of Maxibrite briquettes at a time. Do not overload the fire bed with more than two or three small logs at a time.



Once you have a good fire bed established across the grate, further fuel can be added step by step as required. A good indication of a well established smokeless fuel fire is the widespread coverage of grey ash on the black fuel pieces. Don't be tempted to overload the fire bed with fuel all at once or close down the

air controls too much until the fire is really well established for some time. Once the ignition period is well under way, gradually reduce the air controls then fully close the primary air if burning wood and use the controls to establish the burning intensity you require.

6.11. Re-fuelling

When burning Maxibrite the fire will begin to die down with a significant amount of white ash showing amongst the fuel. *Gently* run a poker through the fire bed to remove most of the ash into the ashpan. Empty the ashpan if it is nearly full and then re-fuel with a good load of briquettes. The fuel load should initially be level with the top of the fuel retainer and not above the rear firebox liner. Whilst approval test cycles are 1 or 2 hours, a stove burning Maxibrite may be kept in overnight easily under normal conditions.

When burning wood, the fire will die down as the fuel is consumed. When the flames disappear and the remainder is breaking down into glowing embers it is an appropriate time to consider re-fuelling. Generally unless the firebox and firebed has cooled down and it is being revived up to working temperature then it's **not** appropriate to re-fuel when the logs are still flaming fiercely. NOTE: If the flames disappear and there are still lumps of solid wood left this indicates excessive internal moisture in the wood, too low a firebox temperature (running too cool), too small a fuel load or insufficient air supply/flue draught.

NOTE: To eliminate unwanted smoke emission, after loading new logs on to the fire, open the air wash control up fully for 3 - 5 minutes or until the logs are well blackened all over to boost the fire and get flames issuing from the top of the fuel as soon as possible. Move the door ajar for a time if necessary to establish flames. When flames are well established, reduce the air wash to the running setting required. **Burning without flames above the fuel will create unnecessary smoke.** Do not load fuel above the rear firebrick at the back of the firebox.

Loading 1 or 2 medium-large sized logs weighing 1-2kg DRY will produce a good output with reasonable burn time. Small logs will burn up quicker producing a high output and more emissions for a short time, and a large log will take longer to burn and produce less output and less emissions over a given time. These appliances are approved for intermittent operation on wood (typically 0.75 to 1.5 hour burn cycles) although longer burn times can be achieved by fully loading the firebox, getting the fuel burning well and then shutting the air controls right down (see below). This will produce a long but smoky/tarry burn (not recommended). The fire will then need reviving by first opening the air controls and then using small pieces of wood and plenty of air to get flames issuing from the wood again. The glass will get dirty if closing the air wash control past the point where flames above the logs disappear – this is quite normal. Never load fuel above the rear firebrick or allow it to spill onto the glass.

6.12. Shutting Down

The stove will normally shut down by itself as the fuel is consumed so there is no need to close the air control towards the end of the burn. In order to shut down the stove for other reasons, close the primary air controls (if open), then close the secondary air control. If the controls are left in this position, the fire will eventually go out but it will also cause the glass to blacken/grey out as the fire dies down. If you want to revive the fire it is recommended that the secondary air controls are opened fully first followed by the primary air control until revived.

Warning! - The stove will remain **very hot** for a considerable time after the fire has died down or been extinguished.

6.13. Shut down for prolonged periods

If the stove is to be left unused for a prolonged period of time then it should be given a thorough clean to remove ash and unburned fuel residues. To enable a good flow of air through the appliance to reduce condensation and subsequent corrosion damage, leave the air controls fully open. It is important that the flue connection, any appliance baffles or throat plates and the chimney are swept prior to lighting up after a prolonged shutdown period.

6.14. User Maintenance

See also the Cleaning section above and Maintenance Guide Section below for further information.

Inspect the inside of the firebox and above the baffle plate every week during use.

Where the chimney is believed to have previously served an open fire installation, it is possible that the higher flue gas temperature from the stove may loosen deposits that were previously firmly adhered, with the consequent risk of flue blockage. It is therefore recommended that the chimney be swept a second time within a month of regular use after installation. **See chimney cleaning section.**

Warnings and Important Information. Inspect the inside of the stove and the flue ways and ensure they are 100% clear after a period of disuse (e.g. summer).

Only use manufacturers recommended replacement parts on the appliance.

Check all rope seals and glass gasket seals for completeness, wear and that there are no gaps between the ends etc. Any gaps must be eliminated and ropes must be re-adhered to their grooves with suitable rope seal cement where required. **Worn or missing rope or glass gasket seals will affect appliance operation, control and emissions output and can lead to overheating damage.**

Check all air intakes and outlets within the stove for cleanliness and remove any ash or debris build up by suitable means.

Check outside air ventilators and stove air inlets are clean and unobstructed.

Only use manufacturers recommended replacement parts on the appliance.

7.0 Maintenance Guide

- 7.1 **Removing Door.** Open the door to approximately 30 degrees and lift away to disengage the hinge pins. Note that it is not necessary to remove the door to clean or remove items from inside the firebox.
- 7.2 **Removing Fuel retainer bars:** The fuel retainer bars also retain the side firebrick liners. Lift bar assembly up until it can be rotated and removed from the firebox.
- 7.3 **Removing Firebox Liners:** Gently move either side firebrick forwards and slightly towards the centre of the grate to release them from the rear liner. There is a mitre joint at the rear which retains both when in position and when disengaged frees all components. **NOTE: Make sure the rear firebrick does not fall forwards and break as the side liners are released!**
- 7.4 **Removing Baffle Plate:** Slide the baffle plate slightly towards the front of the stove and lower it off the rear support then the front pins. Rotate the baffle slightly and remove through the front of the stove. The upper baffle plate can now be removed by unscrewing the stainless steel securing screws and lifting away. The flue can now be swept through the stove.
- 7.5 **Removing the grate:** Remove the fuel retainer, firebrick liners and baffle as above. Lift out the grate castings from the stove firebox.
- 7.6 **Changing the ceramic glass panel:** From time to time the ceramic glass panel or its gasket seals will need to be changed. Note that ONLY ceramic stove glass in the same thickness can safely be used. This is easiest to accomplish with the door removed from the stove and placed face down on a cushioned surface such as cardboard or a folded dust sheet. Firstly clean the inside surfaces of the door and remove the M5 stainless screws that secure the stainless steel glass clips to the door. The glass panel can then be carefully removed. Take the opportunity to clean the glass panel thoroughly if it is to be re-used. Remove all traces of seal from the door casting and clean the surfaces ready for new seals. There is a small woven seal beneath the glass panel instead of gasket paper strips. Fit new seals into place forming a continuous glass seal all around the panel seating area. Line up carefully leaving NO GAPS. Replace the glass panel into position followed by the clips and screws. A strip of gasket material between each metal clip and the glass can extend glass panel life by spreading compression forces evenly. Tighten the four screws in turn to gradually compress the new gaskets and seal the new panel into position.
- 7.7 **Adjusting door:** Adjustment can be made to the hinges. Hinges have a limited amount of adjustment which is achieved by slackening the mounting screws and re-positioning before re-tightening the screws. To obtain greater seal clamping force adjustment the hinge blocks can be shimmed by using metal packing under them to create the correct spacing for the seals in use.
- 7.8 **Replacing door seals:** Rope seals are fixed in place with stove seal adhesive. This is sometimes ceramic in formulation or high temperature silicone such as Heat Mate which is more flexible. NEVER use ordinary glazing or sanitary silicone adhesives as they cannot withstand the temperature. Simply pull away old seals, scrape off excess old adhesives. Apply new adhesive continuously onto the mounting face and apply the new rope evenly all around. **NOTE: Ensure NO gaps at the meeting ends of any continuous loops or butt joints and that the rope sits properly into corners.** Close the stove door and leave to dry for several hours before firing. Seals can be tested by trapping a strip of paper and closing the door

on it. If the paper is trapped then the seal is working. If the paper pulls out then something is wrong and further examination is needed to find the cause.

7.9 Re-painting: All painted solid fuel stoves will require some re-painting from time to time due to heat cycling, wear and tear and corrosion caused by moisture, condensation or products of combustion and ash. The stove can simply be re-painted by using stove spray paint or high temperature coatings after rubbing down with wire wool or similar abrasive to remove all loose debris from the surfaces.

7.10 Re-assembly: This is the reverse of the dismantling procedure – again taking particular care not to drop the firebox liners onto the cast iron grate as re-assembly takes place.

8.0

8.1 FX/FG/FPi 5 Principal Dimensions

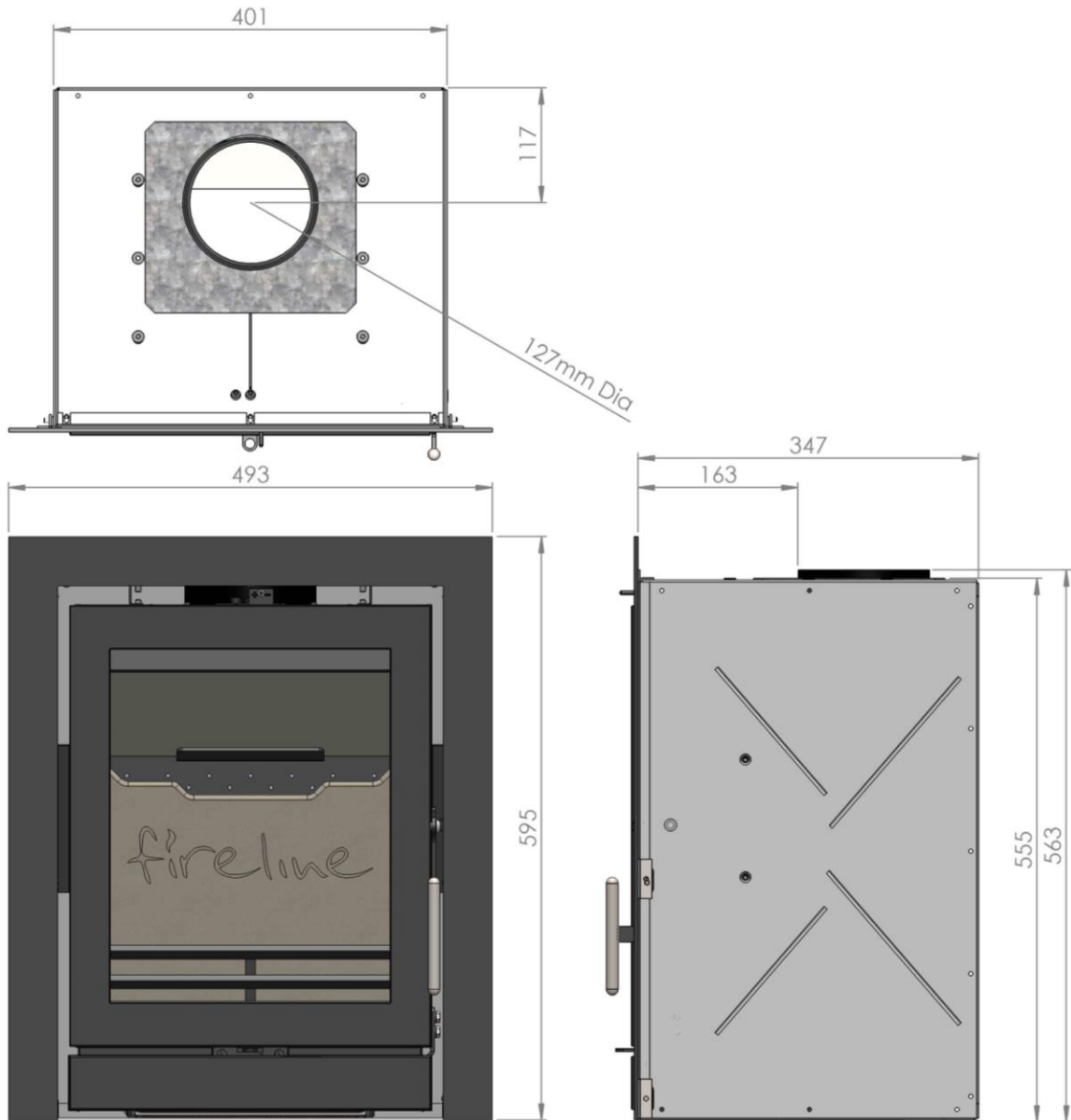

8.2 FX/FG/FPi 5 Wide Principal Dimensions

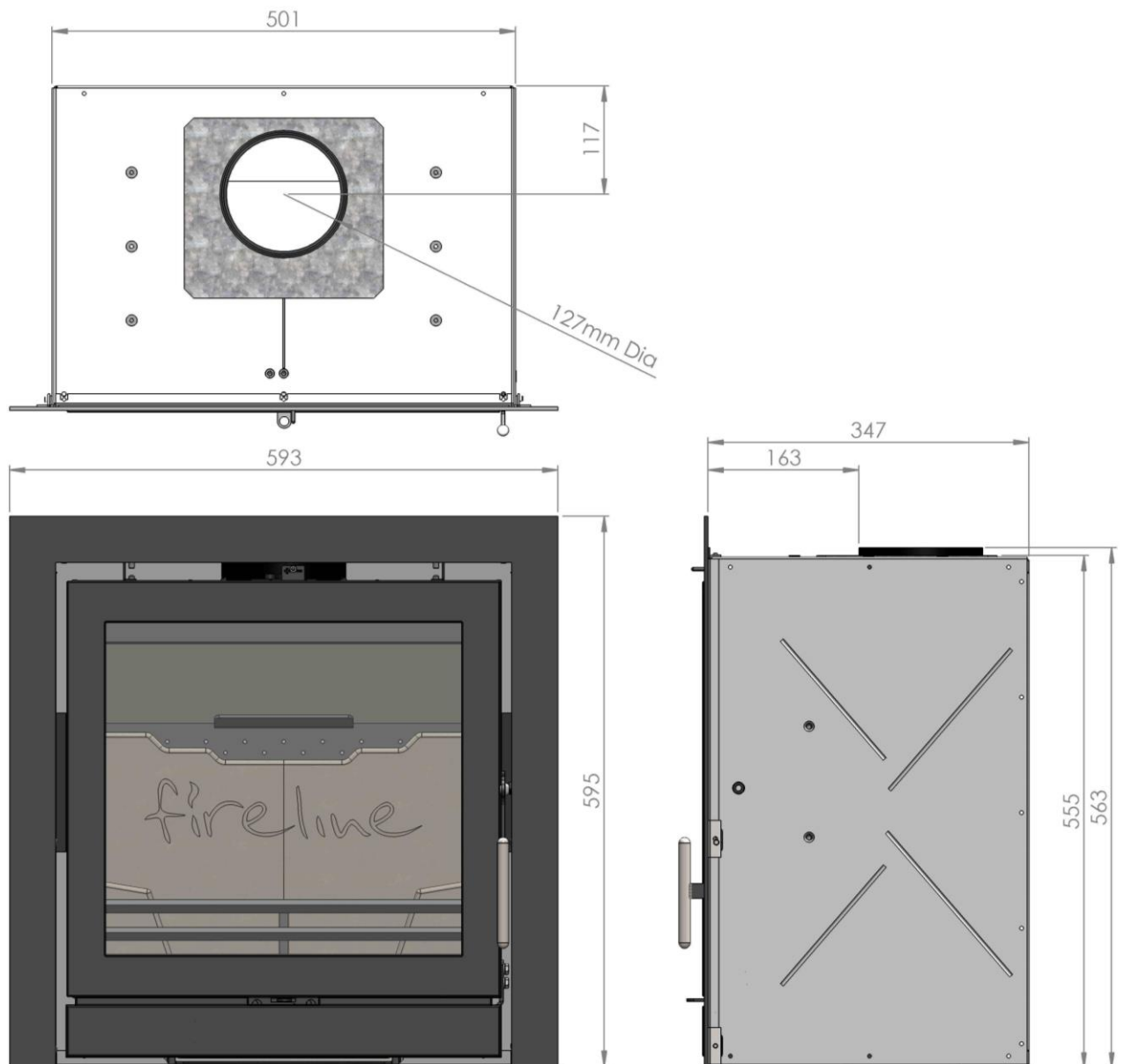

8.3 FX/FG/FPi 8 Principal Dimensions

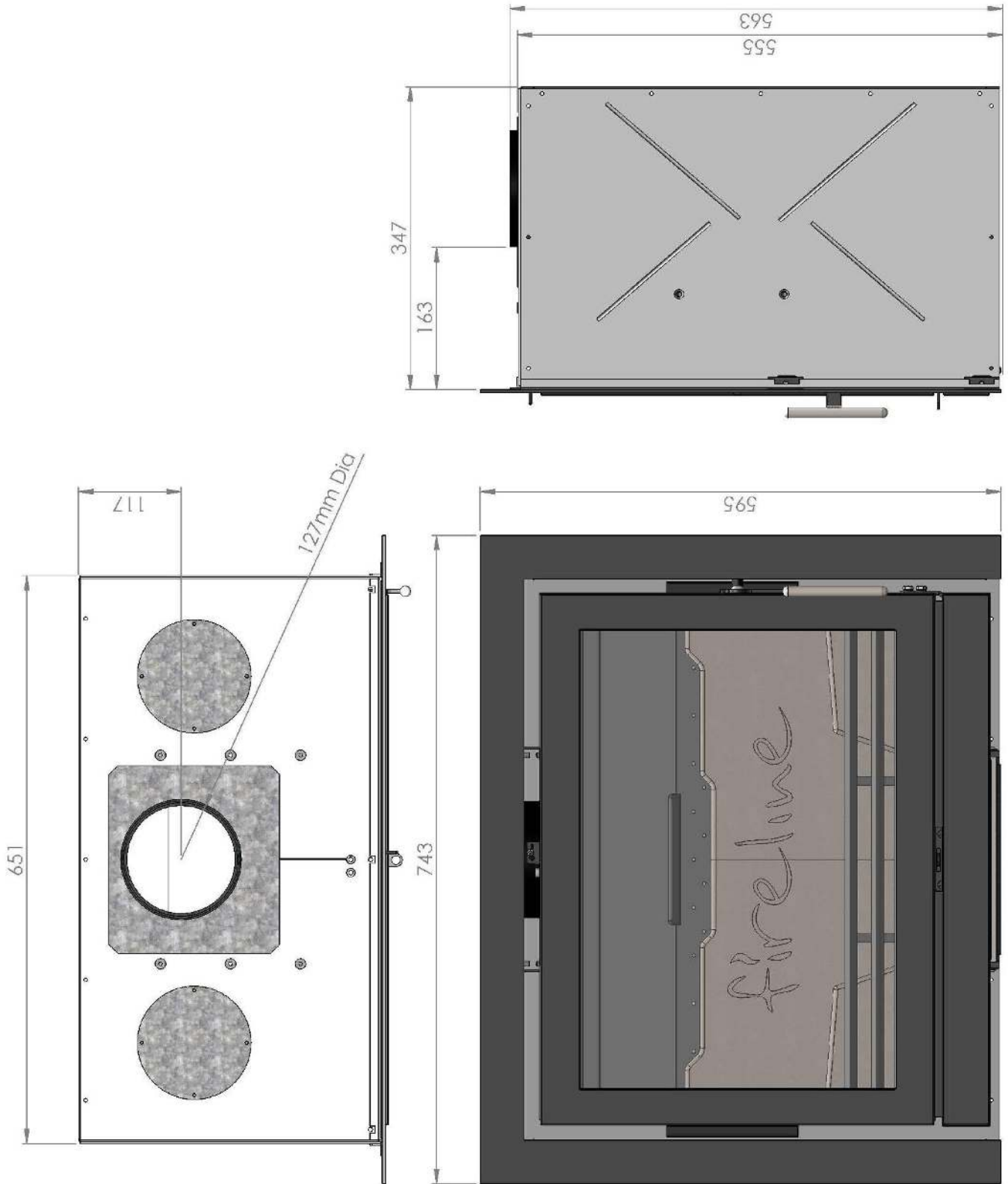

9.0 Frequently Asked Questions

1 Do stoves require a chimney or a liner? All of our stoves require a suitable chimney or professionally installed flue system. A liner may or may not be required depending on flue conditions and only your installer can confirm. Our stoves do not mandatorily require a liner.

2 How do I clean the chimney? You will require a chimney sweep to clean the chimney. It is essential to provide a dedicated chimney cleaning access door when installing the flue of the stove in some situations. In many situations the chimney can be swept through the firebox.

3 Who should install my stove? Charlton & Jenrick want you to enjoy the maximum performance from your appliance. To ensure this, it is essential that they are installed correctly. We strongly recommend that your stove is installed by a suitably qualified installer e.g HETAS.

4 How do I regulate the heat output? Each stove has various air controls, which will allow you to easily regulate the heat output. Output can also be varied by log size and quantity fired.

5 What warranty do I get? Charlton & Jenrick will replace, free of charge, any part that fails (under normal operating conditions) within 12 months of purchase. Consumables such as glass, firebox lining boards or stove rope and adhesives are not guaranteed. We do not accept consequential or incidental liability claims from any product failure. **A call out charge will apply if our engineer attends any stove problem that is not related to product failure.**

6 Where can I get spare parts? Your local stove retailer will be pleased to supply spare parts and to provide any other information you require. Alternatively contact Charlton & Jenrick.

7 Can the doors be left open while burning? For safety and heat efficiency the doors should remain closed. These stoves are not designed or approved for doors open operation.

8 Why is the stove smoking when lit? A flue with lack of draught problems is almost certainly the cause of a smoking stove. Also check adequate ventilation is present – if opening a window or door stops the smoking then lack of ventilation is the probable main cause. A qualified fitter should complete both a smoke pressure and flow test prior to fitting the stove to ascertain the integrity of the flue.

9 Why should I “Run in” my stove? To begin, light a series of small fires over a period of a few days to allow the paint finish to cure. The stove is finished with a highly heat resistant paint. The finish can be renovated with stove paint available from your stove retailer. If the stove is not “run in” correctly, this may cause the paint to discolour and flake.

10 What is Over Firing? Over firing is overheating your stove by having the fire burning too fiercely. Your stove should never be used in a manner to cause over firing. Over firing can be caused by over loading the stove with fuel or leaving air controls fully open or operating the stove with leaking or defective door rope seals. If any part of stove glows red hot then your stove is over firing and your air control should be adjusted to reduce airflow to stove immediately. Over firing can cause permanent damage to the appliance, which is not covered by warranty.

Charlton & Jenrick Ltd

Unit D Stafford Park 2, Telford, Shropshire, TF3 3AR

T: 01952 200 444 F: 01952 200 480

A Charlton and Jenrick Group Company